

# Amplus™

*your trust is our goodwill*



**DESIGN** is thinking  
made visual

## INTRODUCTION

**AMPLUS™** is a brand of our business venture of **KRISHNAV CORPORATION**. We are Importer cum distributor of branded Modular false ceiling system such as Mineral Fiber Ceiling Tiles, PVC Gypsum Ceiling Tiles, PVC Honeycomb Ceiling Tiles, GI & Aluminum Ceiling Tiles, GI T-Grid system, Gypsum Board, Gypsum Powder, Perforated Gypsum Board etc...

We have vast experience in import of the above products to all Asian, Middle Eastern, European countries as well as to some countries in the African continent.

We offer the best quality products with the most competitive pricing and on time delivery.

We sincerely welcome clients from both at home and abroad to visit and develop business ventures with us.

# PVC Laminated Gypsum Ceiling Tiles

PVC gypsum ceiling tile is made of high quality paper-faced gypsum board with a layer of PVC on surface and aluminum foil on its back. It is an environmental friendly, light weight, high quality, Fireproof, Heat resistance and corrosion-resistant decorative ceiling tile.

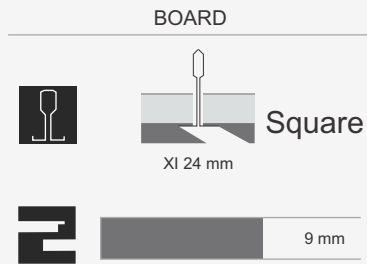

595x595x7mm/8mm

UK Class 0/Class 1 (BS 476 Pt - 6&7)

$\lambda = 0.24 \text{ W/mK}$

$= 7 \text{ Kg/m}^2$

- Surface : Vinyl Lamination
- Back Side : Coated with Aluminum Foil
- Humidity : Resistance (RH) 99%
- Light Reflectance : 98%
- Fire Resistance : 120 Mints



154



246



569



975



991

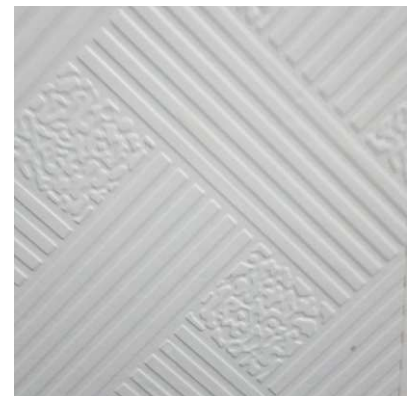

996



238



238-1



3-D

# Mineral Fibre Ceiling Tile

**AMPLUS™** Mineral Fiber Ceiling Tile is a kind of high-grade construction decoration material which has so much performance, sound absorption, fireproof, thermal insulation, mould-proof, sag resistant, energy-saving, environmental protection. It is widely used in indoor ceilings in airports, corporate offices, restaurants, hotels, petrol pumps etc..

	Board	Tegular	Microlook						
	Prelude XL 24mm	Prelude XL24 mm	Suprafine XL15 mm Silhouette						
	9 mm	10 mm	4.5 mm						
	Acoustic Sound Proofing Tiles 600/600/12mm/15mm/19mm								
	Acoustic Sound Proofing Tiles RH99								
	$\alpha_w$	NRC	125 Hz	250 Hz	500 Hz	1000 Hz	2000 Hz	4000 Hz	CAC
	0.60	0.50	0.35	0.40	0.55	0.60	0.70	0.75	=30 db
	EEA Euroclass A2-s1, d0 UK Class 0/Class 1 Wink (BS 476)								
	$\lambda = 0.052-0.057$ W/mK		$\geq 83\%$		99% RH		Board & Tiles =3.9 Kgs/m <sup>2</sup>		

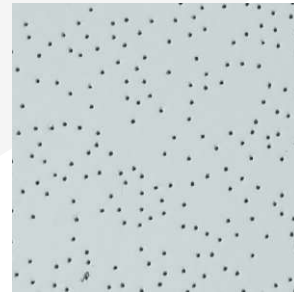

Pin Hole



Fine Fishard



Sand Dune

# Perforated Gypsum Ceiling Tiles

It uses gypsum as the main material. Adding fiber, bonding agents, modifiers, formed by suppressing, Mixing and drying. It has the characteristics of fire sound insulation, heat insulation, light-weight, high-strength, small shrinkage and the stability of small, non-aging, anti-math-eaten.

## Basic Parameters

Product	: Perforated Ceiling Panel	Edge Profile	: Square
Size	: 595x 595 mm / 608 x 1220 mm / 608 x 1830 mm	NRC	: 0.55 – 0.65 with 50mm Glass Wool mats
Thickness	: 9mm /12 mm	Weight (kg/m2)	: 6.5 / 7.6
Surface Finish - Visible	: Vinyl Laminate / Paper Base	K-Value	: 0.16 w/m k
Surface Finish - Back	: Aluminum Foil with Fabric / Paper with Fabric	Perforation Style	: Round Square Two Type of Patterns Available
Core	: Gypsum Plaster	Perforation Rate	: 12-18%

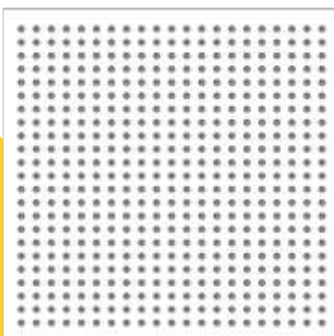

Round Hole

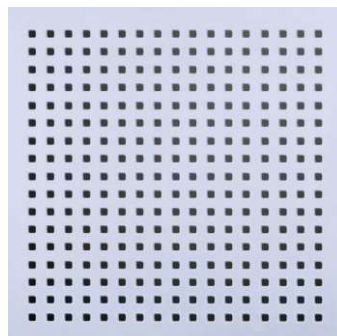

Square Hole

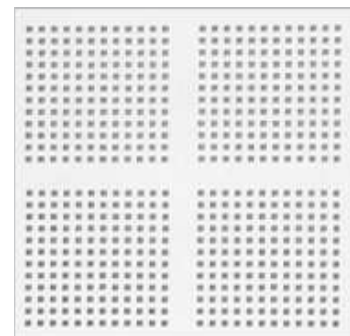

Four Square Hole

## GI T-Section

The **GI-T** Section we offer includes **MAIN TEE**, **CROSS TEE** and **WALL ANGLE**. Our **GI-T** Section is rotary-stitched, for torsion strength and stability to deliver optimum performance. The **GI-T** Section we offer, features a unique connection design for easy and hassle-free installation. Our **GI-T** Section is known for its accurate grid size and robust construction.

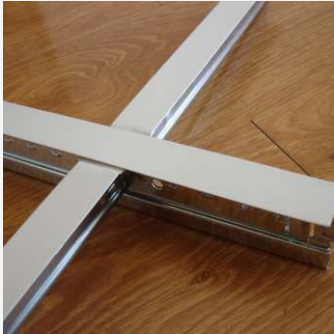

24mm / 15mm Plane



24mm Center Black



15mm Center Black

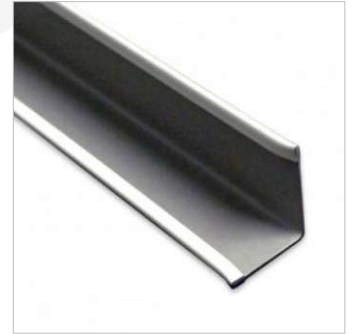

Wall Angle

## PVC Ceiling Tiles

In Recent Years **PVC** has become an Advantageous Alternative than Traditional Materials for Decorating and Rearranging of Interior Spaces in The Various Environments Such as Residences, Hotels, Restaurants, Industrial Units, Individual Offices, Bathrooms, Kitchens, Laundries etc..



PVC 101



PVC 301



PVC 501



PVC 601



PVC 701

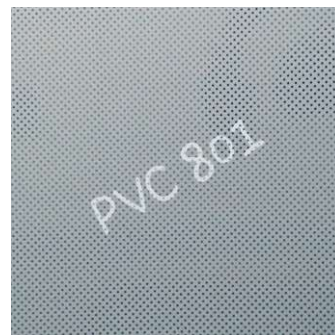

PVC 801



PVC 901

# Metal Ceiling Tiles

## • Clip - in - Tiles :

### Technical Specifications

**Panel:** Clip - in - Tiles are made out of 0.6/ 0.7 mm thick Aluminum /0.5 mm thick Galvanized coil coated on a continuous paint line produced on advanced equipment. Each tile would be raised and piped and stopped to ensure positive engagement into the clip-in-profile or spring tee, yet allow for demounting of individual Tiles. All Tiles would have option of square or bevelled edges. Standard size of Planks are 600 x 600 mm. Clip - in - Tiles are available in various colours. Finishes E perforations. Clip - in - Tiles are also available in 600 x 1200 mm.



Perforated Metal



Plain Metal

## • Lay - in - Tiles :

### Technical Specifications

**Panel:** Lay In Tiles are made from 0.5/0.6/0.7mm thick Aluminum / 0.45 / 0.5mm thick Galvanized steel coil coated on a continuous paint line produced on advanced equipment. Which would include several leveling stages. These Tiles have a flange on each end. This lay on the exposed "T" grid. The Tiles can be laid and easily removed without the aid of special tools. All Tiles would have square / beveled edges. **AMPLUS™** lay -in- tiles are available in various colors, Finishes E perforations.



Perforated Metal



Plain Metal

# Gypsum Board

These boards are also known as plaster boards that are made using gypsum plaster that is pressed between two thick sheets of paper. Our products are widely used in making interior walls and ceilings. In addition to these, we offer Standard Gypsum Board that are used for the interior walls and ceilings.

One principal advantage of gypsum board over plywood, hardboard, and fiberboard is its strong fire resistance. Gypsum products also provide sound control, economy, versatility, quality, and convenience.

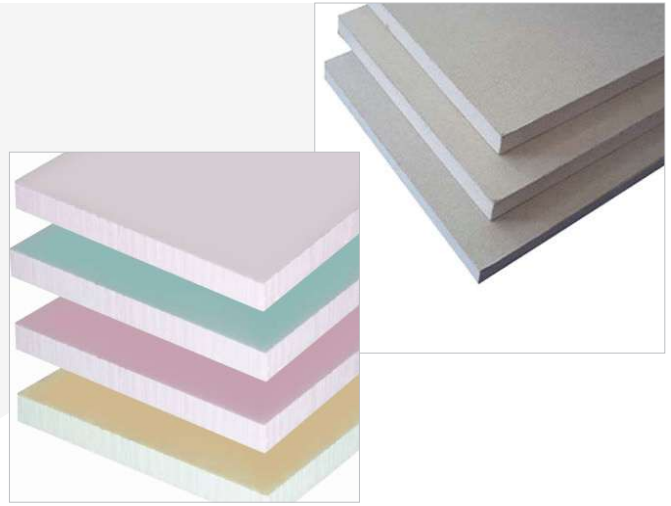

# PVC Decorative Ceiling Tiles

You can use these tiles on your ceiling & wall to make your home or business place look more beautiful. We have hundreds of options for you to choose from. We have helped people with residential and commercial spaces to improve the look of their rooms and offices. Its available in different sizes like 12"x12" , 24"x24" , 48"x24" for your require space.

## Qualities of our Product:

- **Afford Ability:** Due to the materials used in decorative ceiling tiles, we're able to provide a high-quality look for your home and office at a much lower price.
- **No echo:** Softer surfaces do not bounce sound off as in the case of real metal.
- **Lightweight:** PVC and styrene are lighter than our tin, aluminum, or solid copper.
- **Easy Install:** Light weight, direct glue-up or drop-in application, and easy-to-cut tiles make the installation process easier than real tin.
- **Class a Fire-Rated:** Our PVC ceiling tiles are approved for commercial installation in restaurants, hotels, and stores. When you shop in our store, you get only the best faux-tin ceiling tiles for your project.

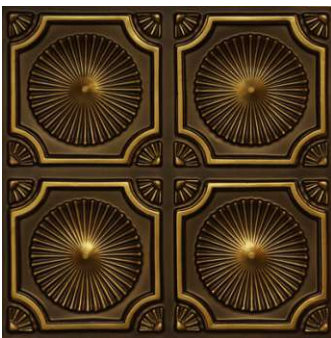

AM 1



AM 2



AM 3



AM 4



AM 5



AM 6



AM 7



AM 7

# Linear Ceiling

For the stylized elegance of ceiling, Architects & interior designers all over India are preferring Metal Ceilings. Linear ceilings are available in wide variety of profiles like I SOF I 200F I 84C I 84R I 150C I 7SC I 22SC etc..

Linear Ceilings are most conventional. It aesthetically most appealing. Manufactured with world class standard the clear lines. It joints of linear Ceilings impart perfect symmetry to ceiling giving a decent polished looks. Linear Ceilings are most preferred at airports, Passages, Lobbies, Petrol Pumps etc. Linear Ceilings are available in wide variety of finishes, Perforations & colours.

Linear ceilings can be used in mono colours or combination colours to suit your interiors. Linear Ceilings are also widely used for wall cladding & exterior cladding.

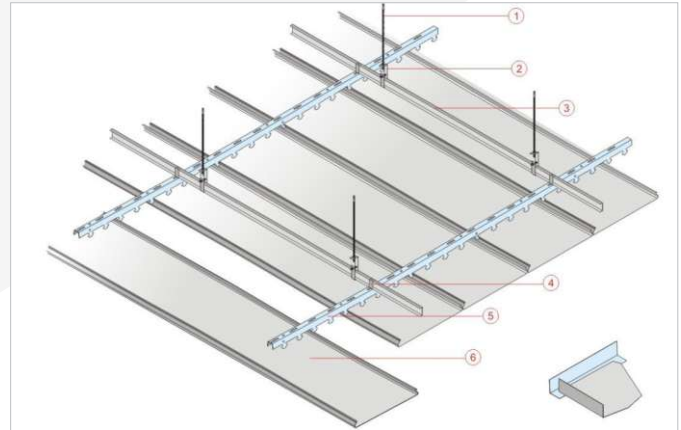

[www.amplus.co.in](http://www.amplus.co.in)  
[info@amplus.co.in](mailto:info@amplus.co.in)



**Krishnav Corporation**  
18-21 Mahalaxmi ind.Estate-II,  
Bamroli Road, Surat - 394 210